

Ground Control Systems Asphalt Anchor Kit (AAK) Installation Instructions

TOOLS NEEDED FOR INSTALLATION

1. Safety glasses and ear plugs
2. Hammer drill w/ 7/8" x 16" carbide masonry bit
3. Soft face mallet
4. 9/16" box wrench
5. Compressed air
6. 4 oz. water

NOTE: These instructions are for installation of strike anchors in ASPHALT ONLY.

CAUTION: Be sure to wear eye and ear protection when drilling holes.

In the Kit:

1. Asphalt anchor assembly, 3/8 X 16UNC
2. Quick set anchor mix
3. Galvanized steel washer
4. Hex head bolt 3/8" X 16UNC -1-1/2"

Quantity depends on which kit was purchased.

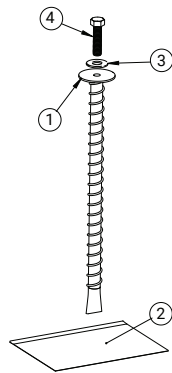

1. Place the rack on the surface where it is to be mounted, checking for set backs to walls, curbs, pedestrian walkways and wheelchair accessible areas.

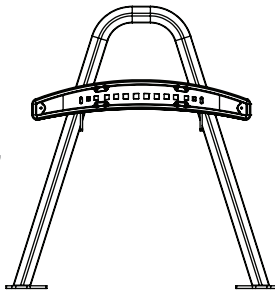

2. Use the flange as a template to mark the placement of the holes- removing the flange once the holes are marked. Wearing eye and ear protection, insert a 7/8" bit and drill the hole to a 14" depth.

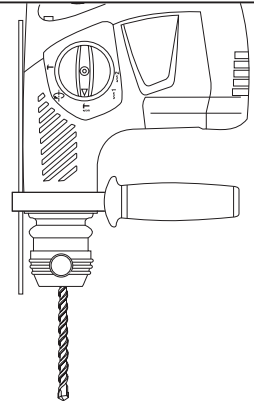

3. Clean out and around the holes with a small blast of air.

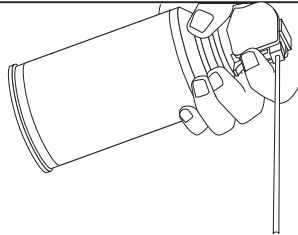

4. Add 4 oz. of water to every 16 oz. of anchor mix, stirring the mix as water is added. The mortar should be a thick paste. Pour the mortar to fill the hole.

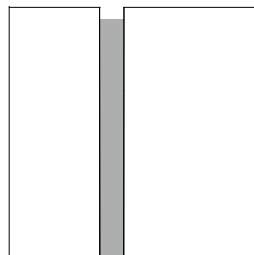

5. Drop in the anchor, making sure it's aligned and flush with the top of the hole. Use a soft face mallet to drive the anchor into the hole if necessary. Remove any excess mortar and wait 15 mins before proceeding to the next step.

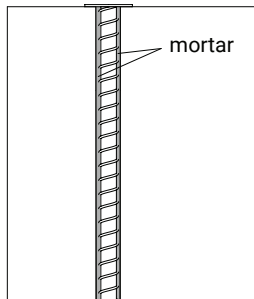

6. Place the flange over the holes, lining them up with the anchors

Insert the bolt with the washer through the flange and finger-tighten the bolt, then use a box wrench to finish tightening 3-4 full turns.

Wait 1 hour before using the rack.

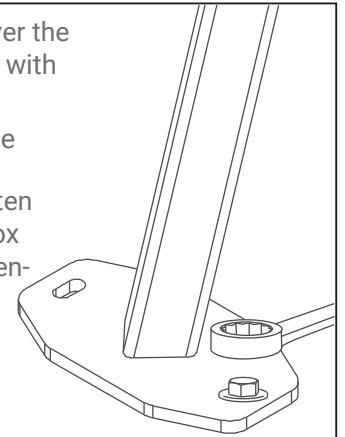

For questions or concerns regarding installation using asphalt anchors, please call Ground Control at 800-630-7225 or email us at info@groundcontrolsystems.com

These installation instructions are intended for the install of asphalt anchors in asphalt only. For instructions on installing a bike dock in other surface materials, please contact Ground Control or download our installation instructions for our concrete anchors.

The information contained in this document is the sole property of Ground Control Systems any reproduction in part or whole without the written permission of Ground Control Systems is prohibited.

GROUND CONTROL
SYSTEMS

www.groundcontrolsystems.com
info@groundcontrolsystems.com
800-630-7225